

DB3

HDCP compliant aluminum motorized monitor

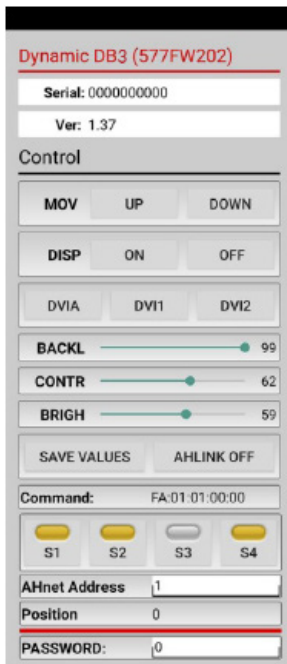
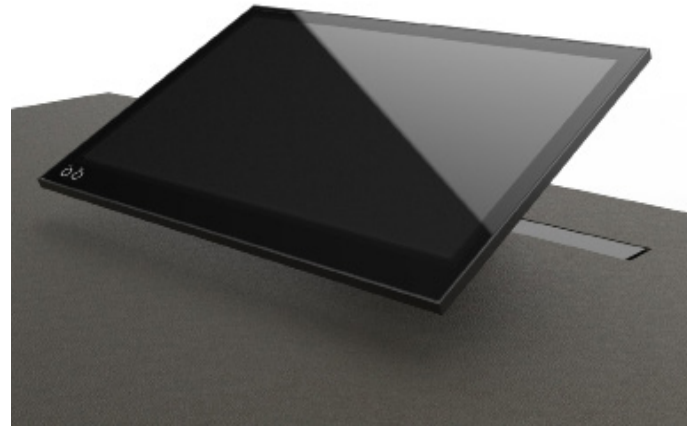

Highlights

- Vertical motorized monitor with inclination of 20-90°
- Adjustable tilt angle with memory
- 10mm edge and total thickness of 20 mm
- Automated hatch in black aluminum or for table surface matching
- Milled black anodized aluminum housing
- Dual side anti-reflective 2 mm. black-edged glass
- Energy saving design, low consumption video controller
- HDCP compliant DVI inputs
- RS422/RS485 I/O
- ISD: Interactive Setup Display for adjustments and setup
- AHlink: Wireless connectivity for setup, adjustments, and control
- AH-AMMC: Auto mechanical Movement Calibration

AHlink : the App for setup, control and diagnose



General

Professional 23.8" motorized monitor with a minimal impact on the table's design when retracted and an astonishing impact on the table when ejected. The automated hatch has a black anodized aluminum finish. The unique design of the automated hatch allows it to be matched to the table surface by adding the same material as the tabletop on top of it, providing a streamlined finish to the furniture. The user can adjust the screen position for comfort and visibility, with full view of the other participants around the table. The screen inclines smoothly towards the user, who can stop the movement and lock the position at the desired angle, from 90 to 20°. A memory function will allow to store and recall the desired position. The elegance of the design is timeless, and the movements are harmonious and silent. The materials selected for crafting this innovative, retractable monitor are sustainable, comprising aluminum and glass. The 23.8" 4K professional display panel ensures a long lifespan. The in-house designed electronics prioritize energy efficiency, while the AHlink app

facilitates a comfortable and intuitive adjustment during integration and throughout the monitor's lifespan.

The retractable monitor is equipped with 2 x HDMI HDCP compliant inputs and an Interactive Setup Display for setup, control and diagnose. The monitor provides RS422/485 loop through (I/O) allowing the remote control of the input selection, movements, speeds, safety settings, brightness, contrast and backlight adjustments. It can also be adjusted and controlled via the wireless application: AHlink.

The AHlink app is available for Android and iOS and gives access to the setup menu and information about the monitor, such as serial number and firmware version, without access to the monitor in the table.

The Auto Mechanical Movement Calibration will automatically adjust the speed and the safety protection parameters.

The use of the ERT-30 and the ERT-60 enables an automatic individual address configuration of all the monitors in a table.

Technical Specifications

Display

Size	4K 23.8" TFT Active Matrix, widescreen format. LED backlight
Resolution	3840 (h) x 2160 (v)
Brightness	250 cd/m2
Contrast ratio	1000:1
Pixel	0.13725 (h) x 0.13725 (v) mm
Viewing angle	178°/178°(l/r) 178°/178°(u/d)
Viewing area	527.04 (h) x 296.46 (v) mm
Response time	Tg-g 14ms
Temperature (operating/storage)	Operating 0°C ~ +40°C Storage -20°C ~ +60°C

Materials

Monitor housing	Solid mechanized aluminum housing with black anodized finish. Front black serigraphed glass
-----------------	---

Connectivity

Input signal	2x HDMI - HDCP compliant
RJ45 CAT6 (I/O)	Addressable RS-422/RS-485 control by AHnet protocol
GPI (SubD9)	Up/Down control (opto isolated)
USB	For service (firmware upgrades)

Control

RJ45, RS-422/RS-485 (I/O), AHnet protocol
AHlink
Addressing
Termination switch
GPI
IR Remote control (monitor adjustments)

Movement's Control

User interface on monitor	(Up/Down) Capacitive touch sensor
Remote	RS-422/RS-485 (I/O), GPI
AHlink	

Electrical

External power supply	100-240 Vac, 47/63Hz, 12Vdc
Power consumption	50W

Accessories

ERT-30 / ERT-60	Ethernet Interface Unit
-----------------	-------------------------

Mechanical

Monitor Dimensions:	
Screen	560 x 368 x 40 mm [22.05" x 14.49" x 1.57"]
Top frame	576 x 47 mm [22.68" x 1.85"]
Housing below the table	644 x 630 x 145.5 mm [25.35" x 24.80" x 5.73"]
Weight	26 Kg / 57.32 Lb
Shipping Dimensions:	
Weight	27 Kg / 59.52 Lb
Shipping Box	700 x 685 x 185 mm [27.56" x 26.97" x 7.28"]

ARTHUR HOLM

Albiral Display Solutions SL · Fàtima, 25 · 08512 Sant Hipòlit de Voltregà · Barcelona, Spain · +34 938 502 376 · marketing@arthurholm.com · www.arthurholm.com
Arthur Holm is a registered brand of Albiral Display Solutions SL. Specifications subject to change without previous notice.

Make Your Meetings Count!

Options and accessories

- DynamicTalk
- Projected capacitive multi-touch screen
- Integrated USBC retractable cable
- Motorized USB camera
- Automated hatch ready for veneering with capacitive sensor

Warranty

- 2 years general warranty

ARTHUR HOLM

Albiral Display Solutions SL · Fàtima, 25 · 08512 Sant Hipòlit de Voltregà · Barcelona, Spain · +34 938 502 376 · marketing@arthurholm.com · www.arthurholm.com
Arthur Holm is a registered brand of Albiral Display Solutions SL. Specifications subject to change without previous notice.

Make Your Meetings Count!

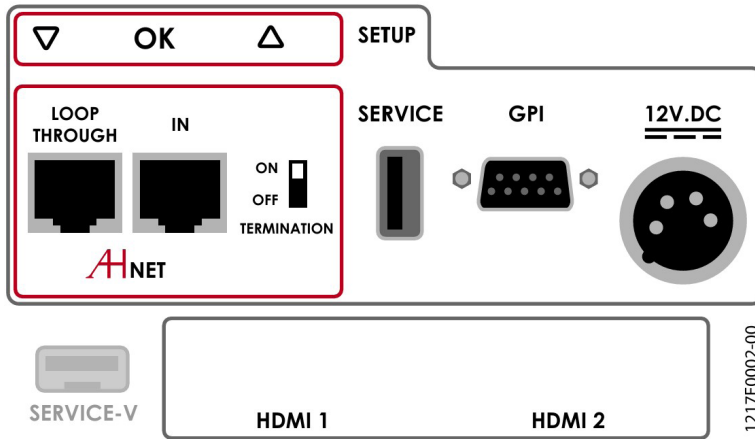

Interactive Setup Display (ISD)

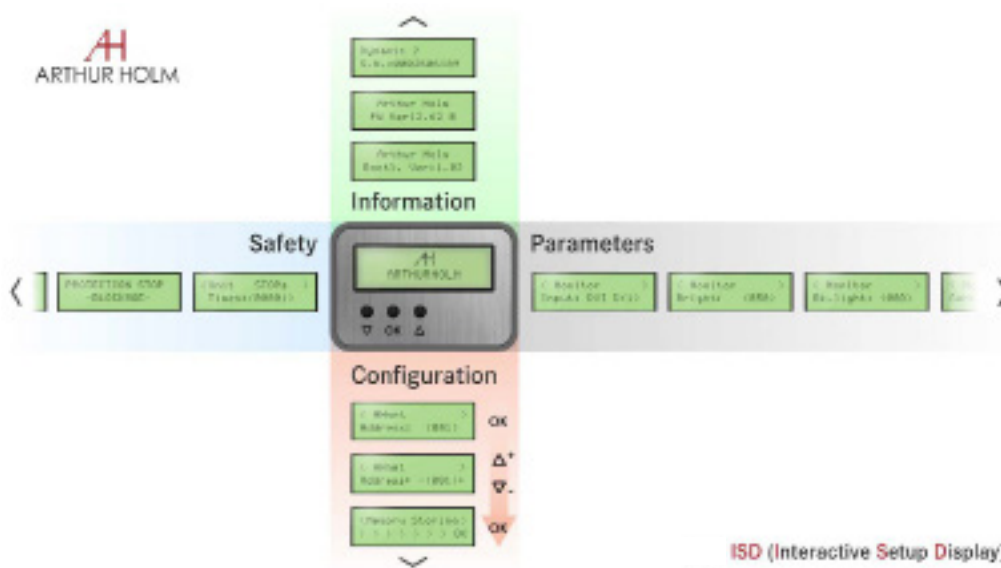

Consultants, architects and engineers specifications

Vertically motorized 23.8” 4K professional monitor with an inclination from 90 to 20 degrees on the desk. The monitor housing shall be made of milled anodized aluminum with a 20 mm. thickness and the screen shall be protected with an anti-reflecting 2 side coating black edged 2 mm. glass. The automated hatch shall slide down inside the mechanism and shall be designed for veneering. A capacitive button shall be placed on the automated hatch to activate the monitor’s movement. A memory button shall allow the memorization of the preferred user’s monitor position and its recall.

The monitor shall have a brightness of 250 cd/m2, a contrast ratio of 1000:1.

The monitor shall provide a USB port for firmware upgrades. The monitor shall be controlled by a wireless Android and iOS App providing information about the monitor’s serial number and providing access to the control and to the setup menu.

General Dimensions

AH24DB3 4K

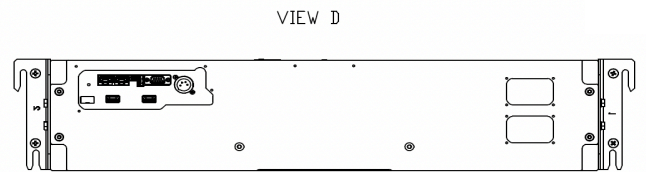
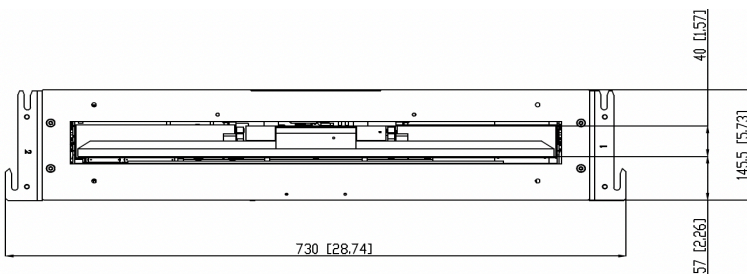
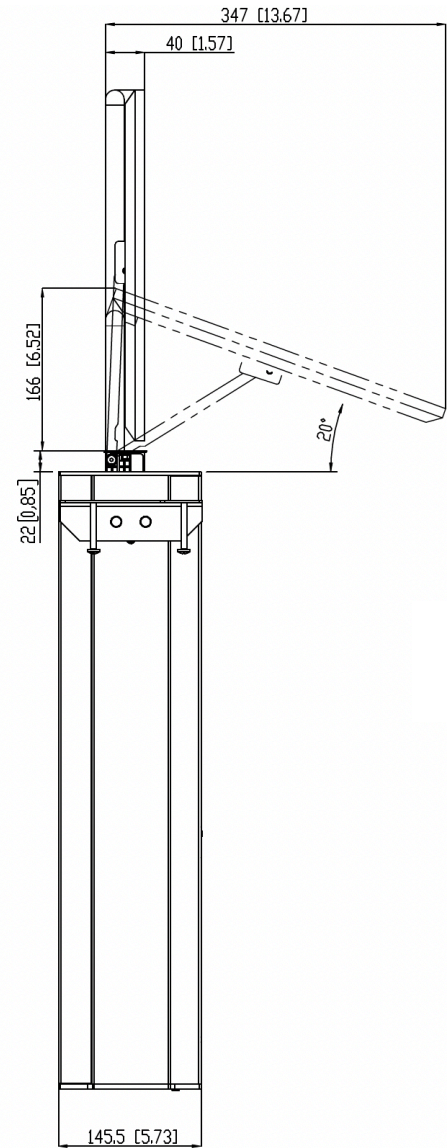
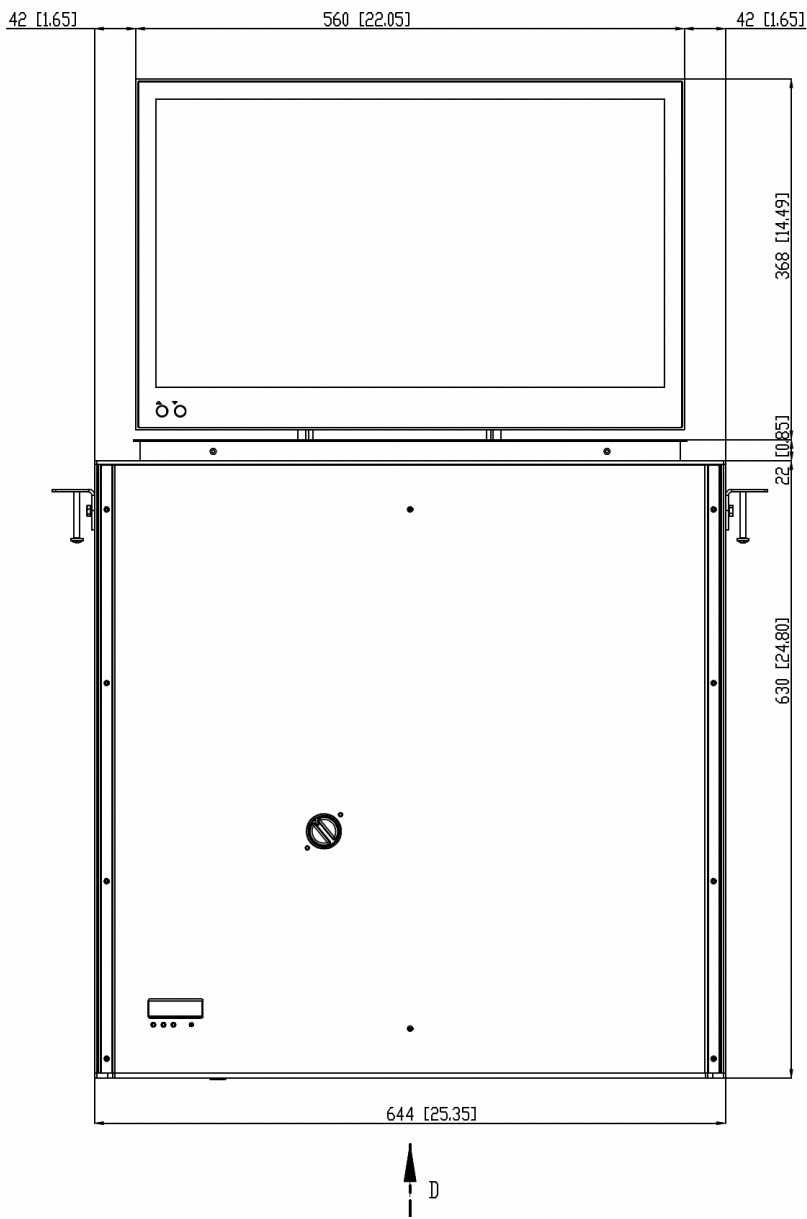

ARTHUR HOLM

Albiral Display Solutions SL · Fàtima, 25 · 08512 Sant Hipòlit de Voltregà · Barcelona, Spain · +34 938 502 376 · marketing@arthurholm.com · www.arthurholm.com
 Arthur Holm is a registered brand of Albiral Display Solutions SL. Specifications subject to change without previous notice.

Make Your Meetings Count!